

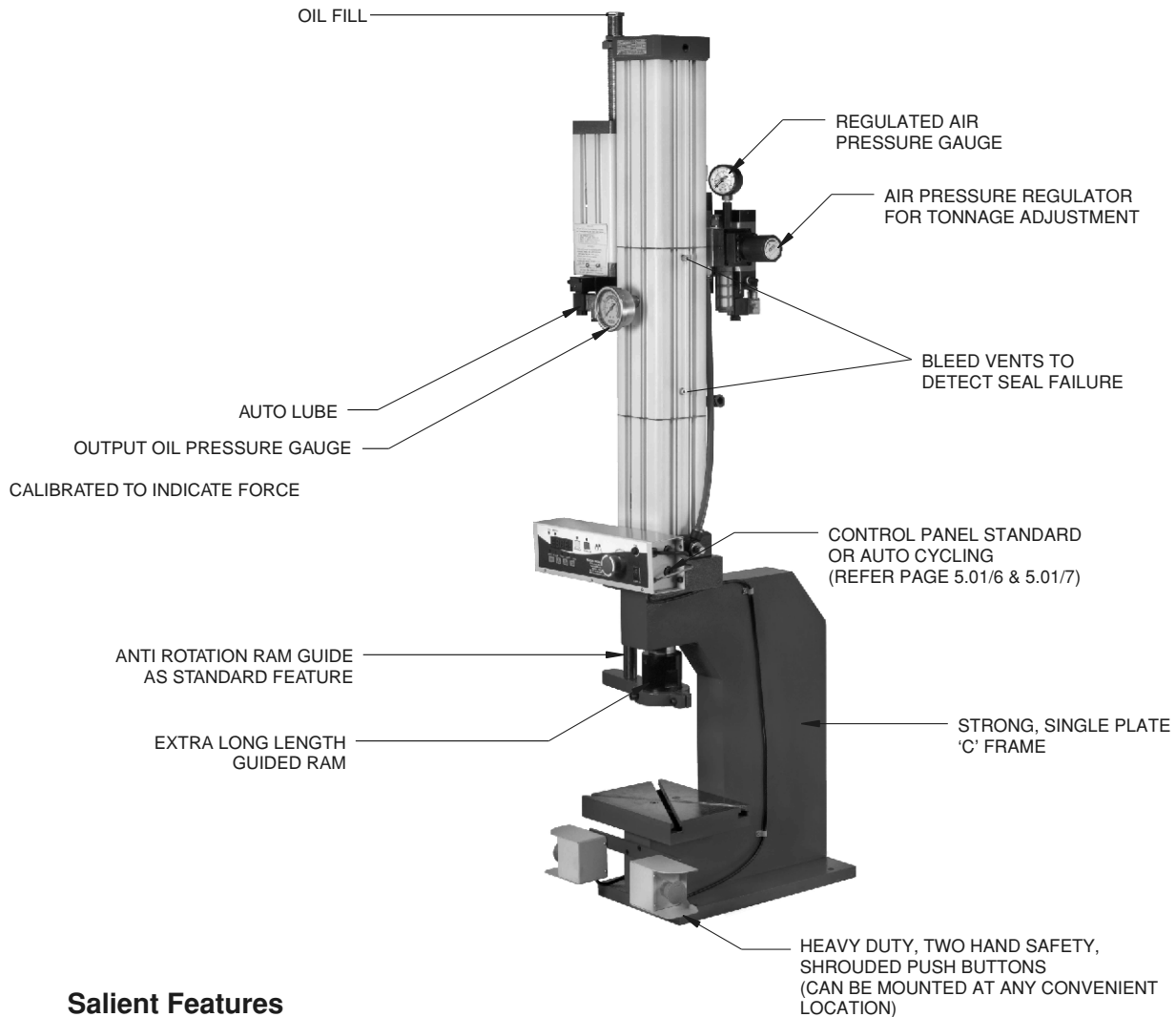

Compact 'C' Frame Presses

with E2HS Control & Anti Rotation Guide

MERCURY



Salient Features

- **Fast Action** : 2T @ 100 cycles/min. (CPM), 4T @ 60 CPM, 8T @ 40 CPM & 15T @ 20 CPM.
- **Compact, light weight & vibration free** : Can be mounted on existing work benches without any foundation.
- **Versatile** : Force & speed can be varied infinitely. Machine can be mounted in any orientation.
- **Energy efficient** : 50% to 75% saving over equivalent hydraulic and pneumatic systems.
- **Low cost** : Upto 60% cheaper than hydraulic presses.
- **Safety** : True, non tie down, interlocked Two Hand Safety operation.

These Compact and low cost 'C' Frame presses are ideally suited for small size jobs like automotive cable crimping, hose pipe end fitting crimping, stamping etc.

Typical Applications

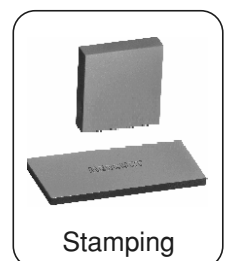
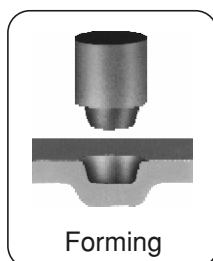
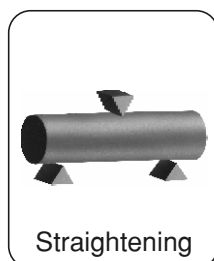
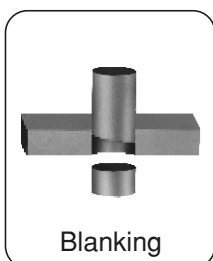
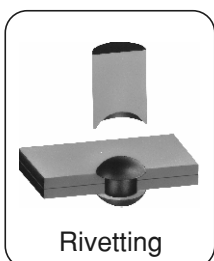

Technical Specifications

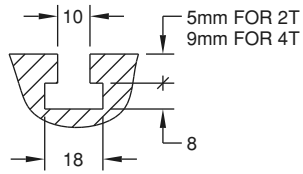
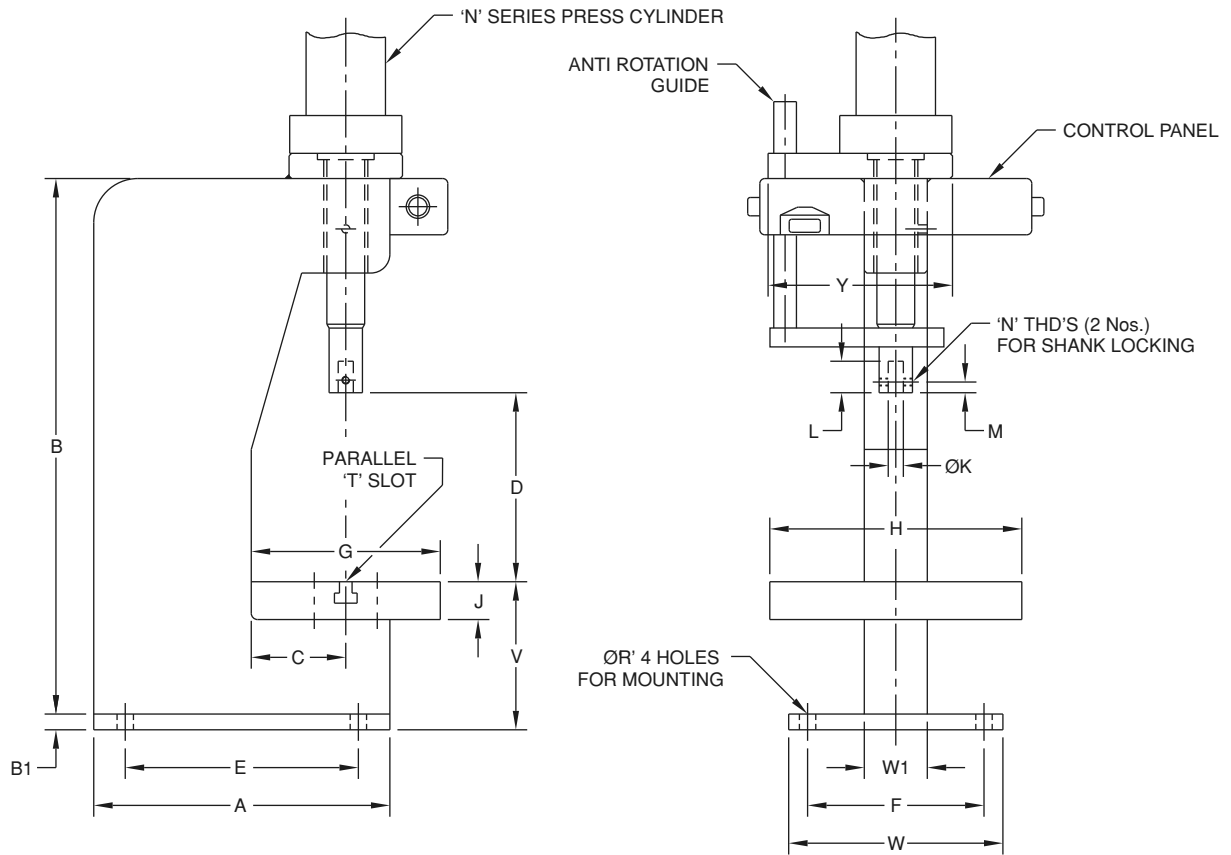

T-10 'T' SLOT

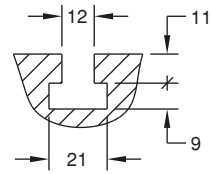

T-12 'T' SLOT

MODEL No.	TON	A	B	B1	C	D	E	F	G	H	J	ØK	L	M	N	R	T	V	W	W1	Y
3C02R	2	245	437	12.5	65	200	200	120	120	150	27	12	30	10	M6	13	10	115	150	35	103
3C04R	4	345	445	15	75	200	300	170	140	200	35	16	30	10	M6	13	10	125	200	50	138
3C08R	8	415	545	19	100	200	320	200	180	250	35	25	30	10	M6	13	12	154	230	72	184
3C15R	15	495	630	-	100	200	420	100	175	300	50	30	40	10	M8	13	12	200	276	276	276